



NATIONAL ALUMINIUM  
PRODUCTS COMPANY SAOG

N40 Catalogue



01 - 2021 - V.01

All rights reserved.

No part of this publication may be reproduced, stored in a retrieval system or transmitted in any form or by any means electronic, mechanical, photocopying, recording or otherwise, without prior permission of NAPCO.





## Index

Company Profile	05
Technical Information	06
N 40 Series	08



## About Us

National Aluminium Products Company SAOG (NAPCO) was established in 1984 and is one of the leading extruders of aluminium profiles in the GCC market. Located in the Sultanate of Oman, the manufacturing plant is spread over 65,000 sq meters in the Rusayl Industrial estate.

NAPCO offers a wide range of Aluminium profile extrusions in finishes that suit functional modern design specifications. The company has left its mark on the architectural landscape of the Middle East with its renowned quality products being used in a number of prominent structures.

Our annual production capacity is 42,000 MT with four (4) state of the art presses. The extrusion presses are complemented by one anodizing line and two powder coating lines (vertical & horizontal). NAPCO also houses two wood finish lines and a crimping and bending facility.

NAPCO's commitment to quality has made it the first extrusion company in the Gulf to receive ISO certifications. We are also the only public limited aluminium extrusion company in the entire GCC.

With a consistent focus on innovative production skills and high service standards, we will continue our objective to meet customer demands and expectations.

## Technical Information on Aluminium extrusions supplied by NAPCO

### A. Equipment & Capacity

Extrusion Press: 4

2000 MT (8') SMS Germany

2800 MT (9') Danieli Breda, Italy

1800 MT (7') Tecalex, Spain

1800 MT (7') Tecalex, Spain

Powder Coating Plant: 2

Horizontal Type, Ercon, UK

Vertical Type, Trasmetal, Italy

Anodizing Line: 1

SAS, Germany

Wood Finish: 2 NATURALL, Italy.

Crimping & Bending Facility.

#### • Current Capacity Per Annum

Extrusion: 42,000

Powder Coating: 27,000

Anodizing: 2,400

Wood Finish: 1,500

### B. General Specification

Max profile size CCD 305mm

(\*indicative size)

### C. Product Range

NAPCO offers a range of over 6000 profiles to suit the architectural and manufacturing industry. NAPCO also develops exclusive dies for customers against their own designs.

#### • Aluminium extrusions in:

Mill Finish

Anodized

Powder Coated and Natural Wood Finish

#### • Façade Systems:

NAPCO is in partnership with world renowned façade system houses in the GCC. Please contact us to discuss your best-fit solution.

### D. Anodizing

NAPCO has one anodizing line employing sulphuric acid anodizing process offering a wide range of colour shades such as Silver, Bronze and Black with scope of development of other shades to suit customer requirements.

Specifications: DC Sulphuric Acid Anodizin  
As per EN 1 - 12373 and BS 1991 3987  
Qualanod Approved

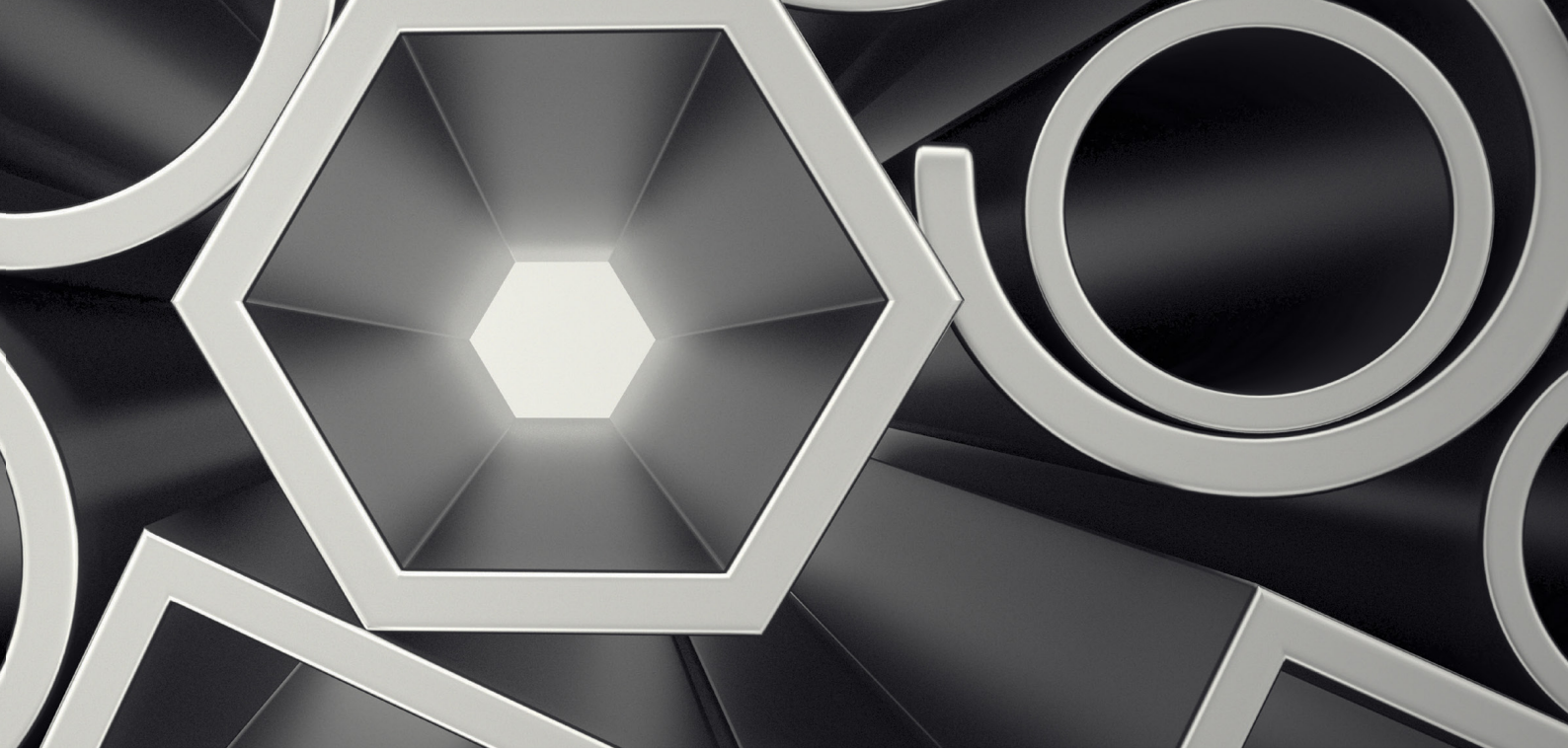

## E: Powder Coating

NAPCO has two powder coating lines (horizontal & Vertical) with IR curing ovens. The colour coat thickness in exposed areas is Around 80-60 microns. The new vertical line is able to accommodate profile lengths up to 8 meters.

Qualicoat Approved.

Natural finish is available in seven combinations of Wood patterns.

Specification: As per 6496

## F. Certifications





# N40 SERIES

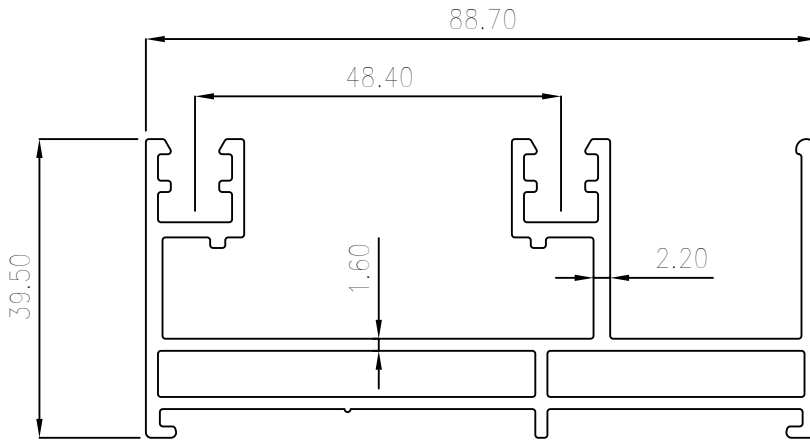

**87001**  
(1.623 Kg/m)

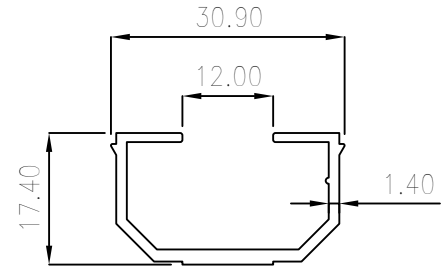

**87011**  
(0.283 Kg/m)

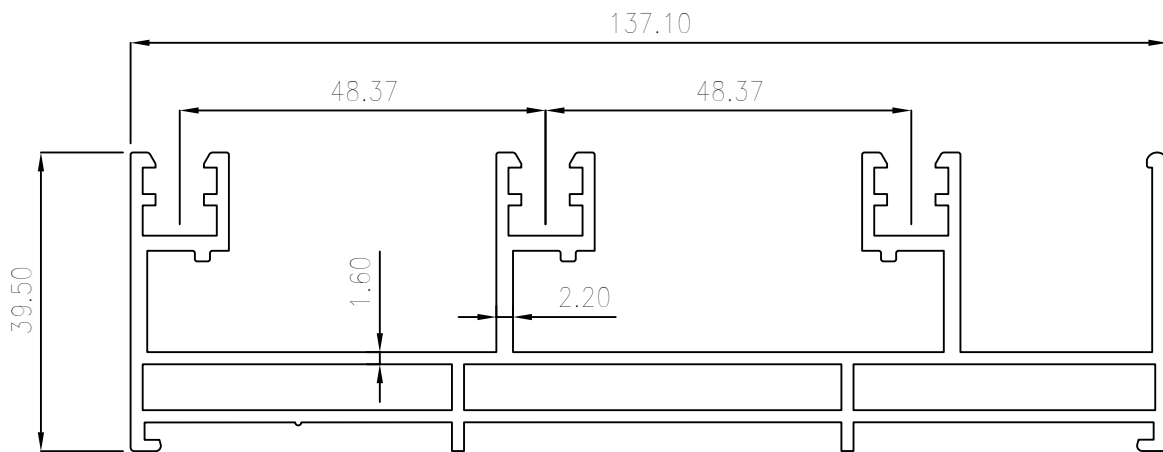

**87002**  
(2.368 Kg/m)

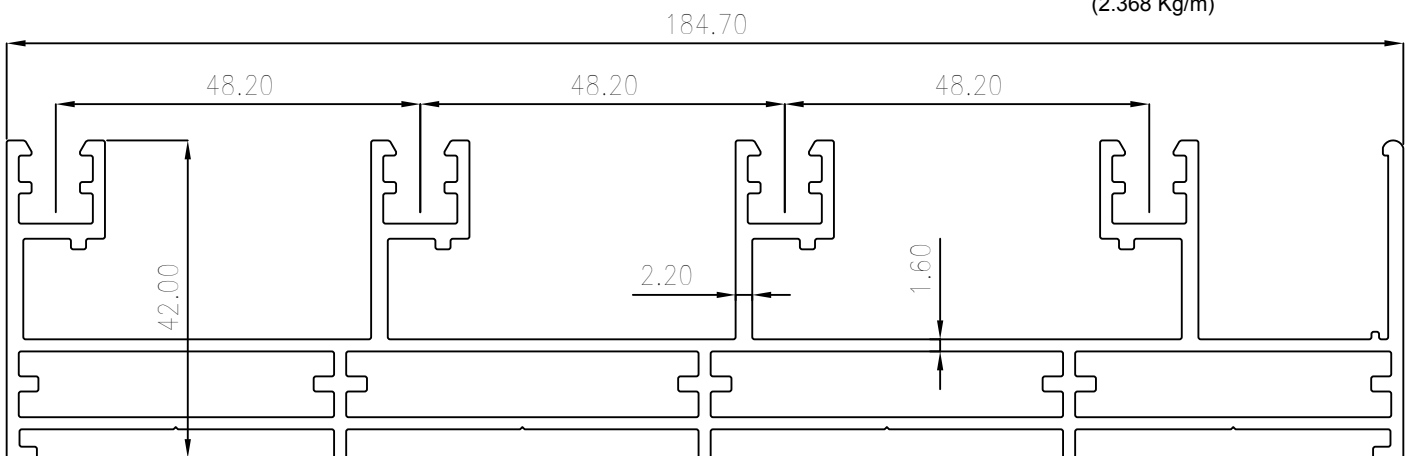

**87003**  
(3.271 Kg/m)

# N40 SERIES

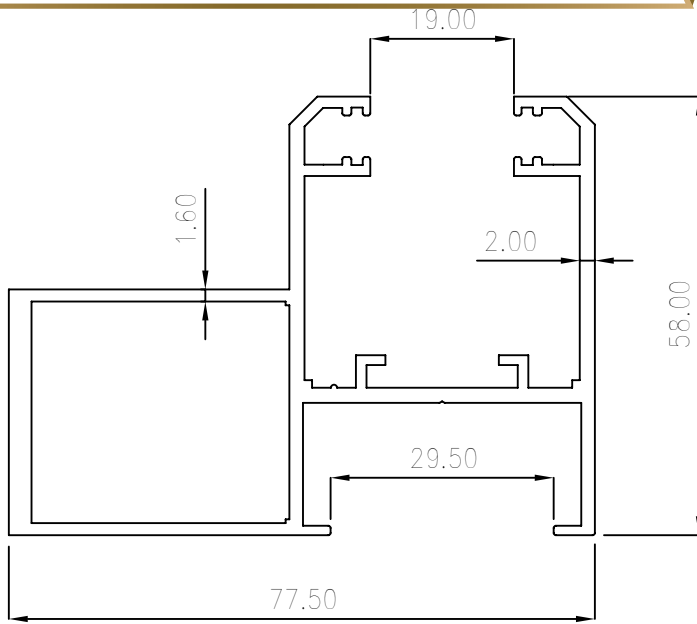

**87005**  
(1.586 Kg/m)

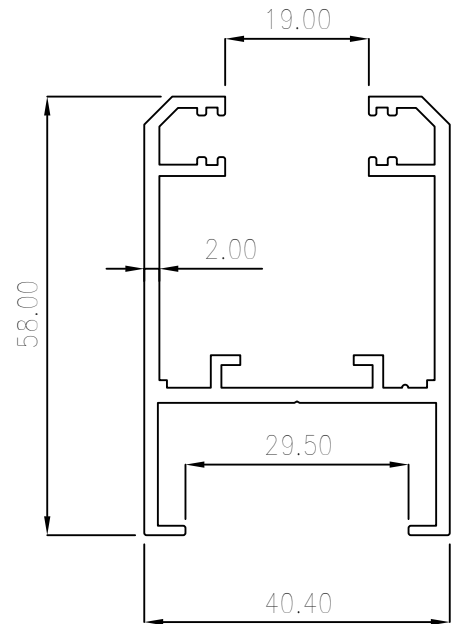

**87004**  
(1.027 Kg/m)

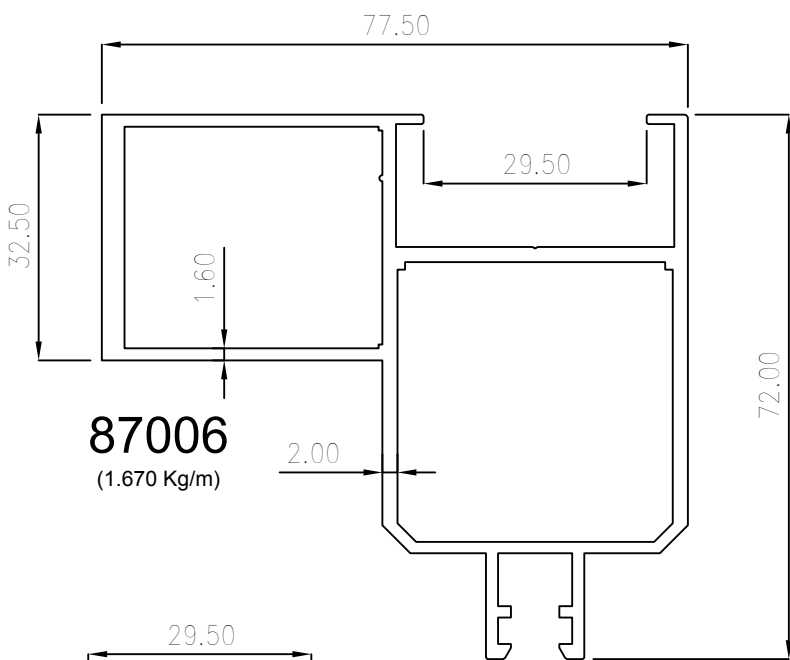

**87006**  
(1.670 Kg/m)

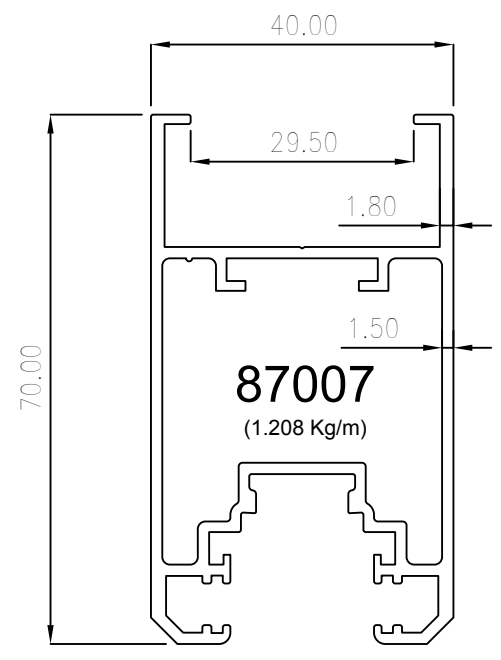

**87007**  
(1.208 Kg/m)

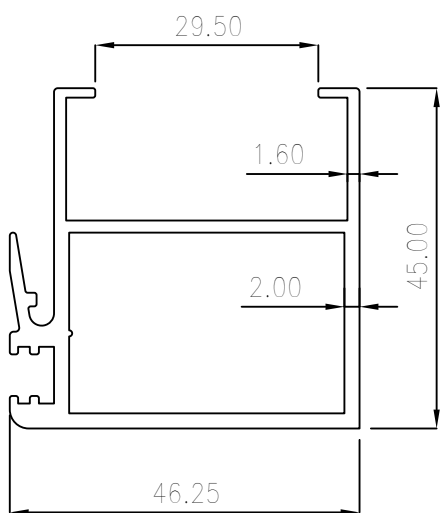

**87008**  
(0.987 Kg/m)

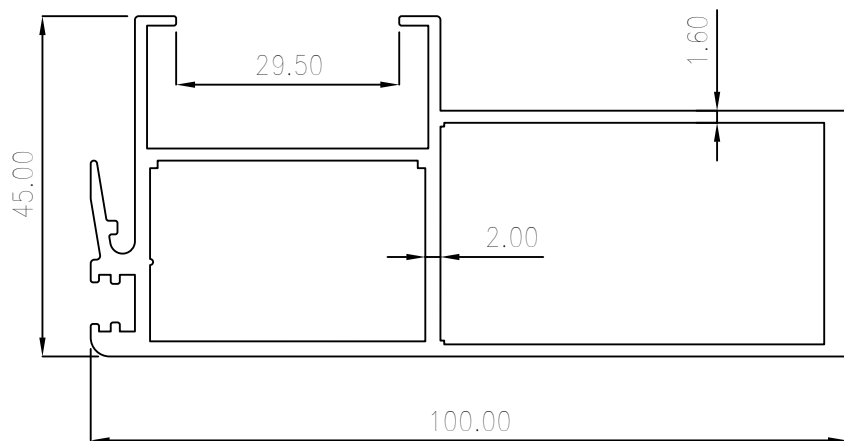

**87009**  
(1.697 Kg/m)

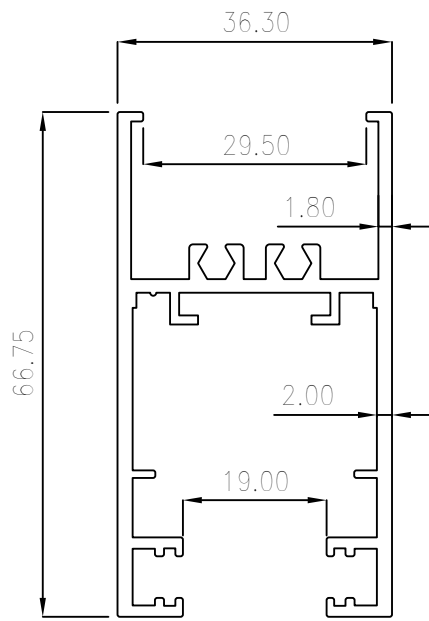



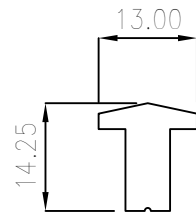





**87010**  
(1.150 Kg/m)

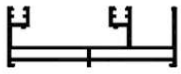

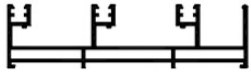
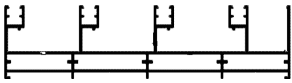
**87012**  
0.268 kg/m

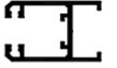
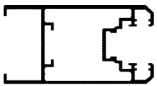
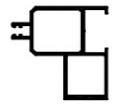
**87012**  
(0.268 Kg/m)

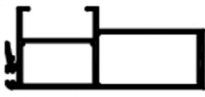
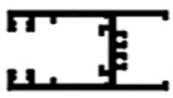
## N40 SERIES

Profile Reference	Profile Section	Page	Weight / KG/M	IX cm <sup>4</sup>	IY cm <sup>4</sup>	WX cm <sup>3</sup>	WY cm <sup>3</sup>
87001		9	1.623	78.112	8.091	15.179	3.456
87011		9	0.283	-	-	-	-
87002		9	2.368	172.194	11.130	24.796	4.810
87003		9	3.271				
87005		10	1.586	41.625	16.554	10.129	4.991
87004		10	1.027	10.461	10.720	5.178	3.632
87007		10	1.208				
87006		10	1.670	41.829	25.834	9.982	5.966
87008		10	0.987	10.644	6.683	4.434	2.391
87009		10	1.697	72.387	11.461	13.632	4.057
87010		11	1.150	15.183	9.452	4.448	5.208
87012		11	0.268	-	-	-	-

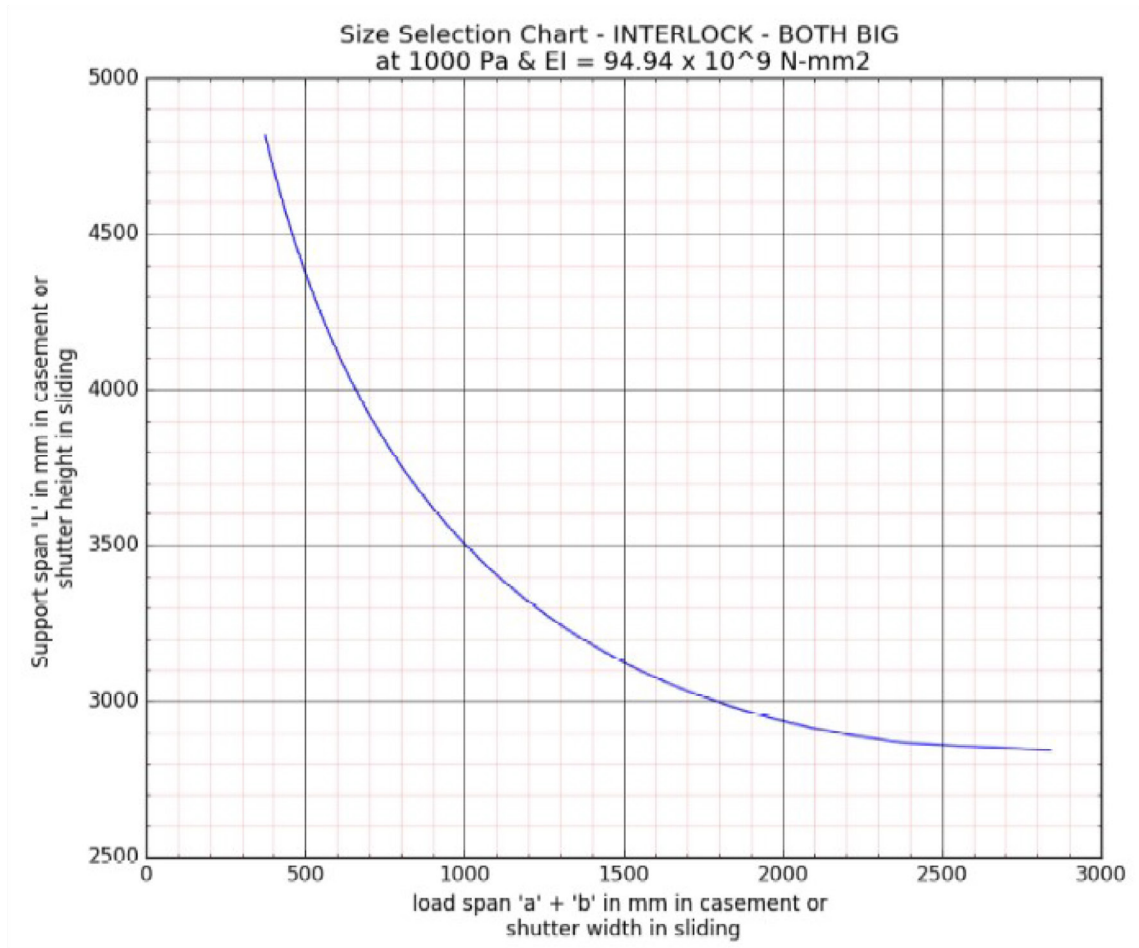
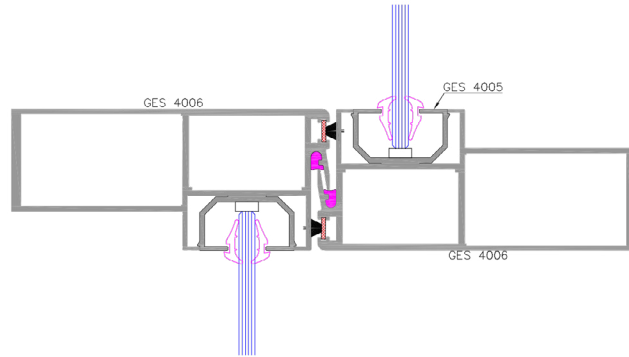

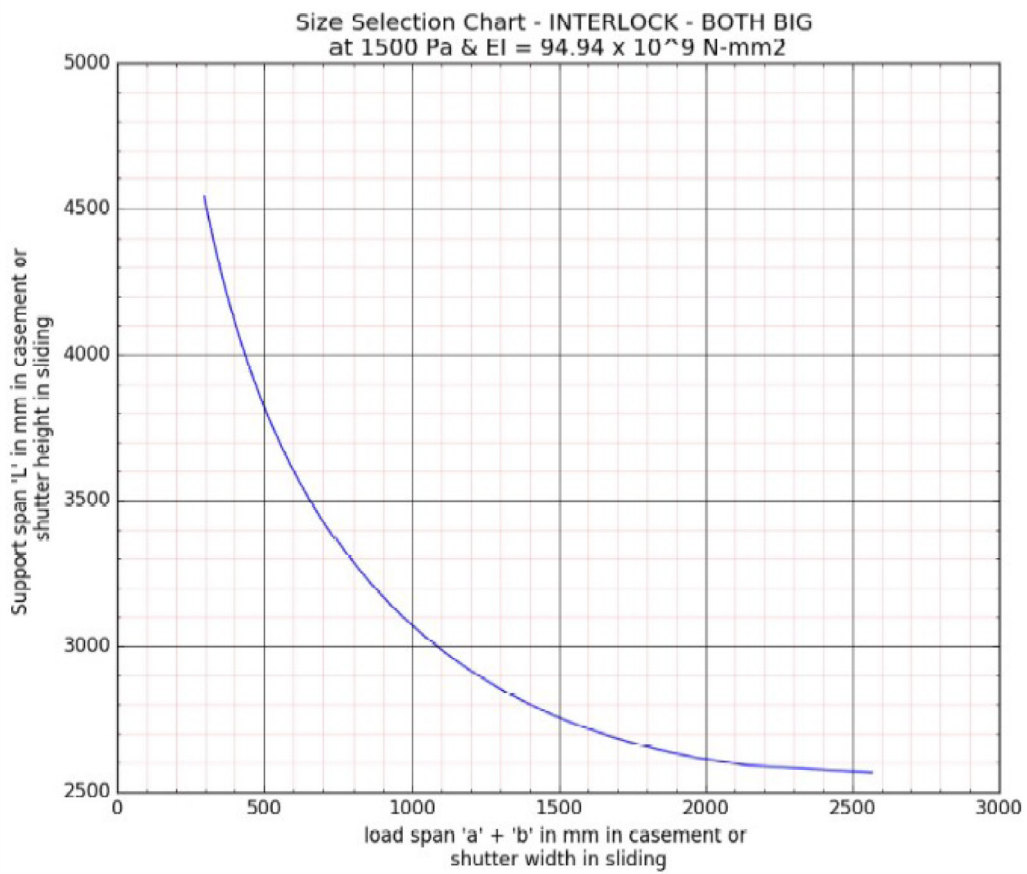
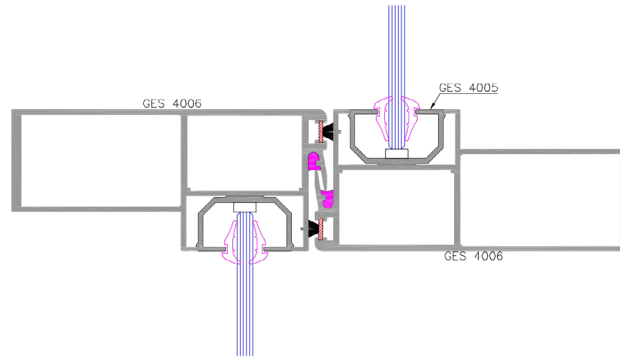

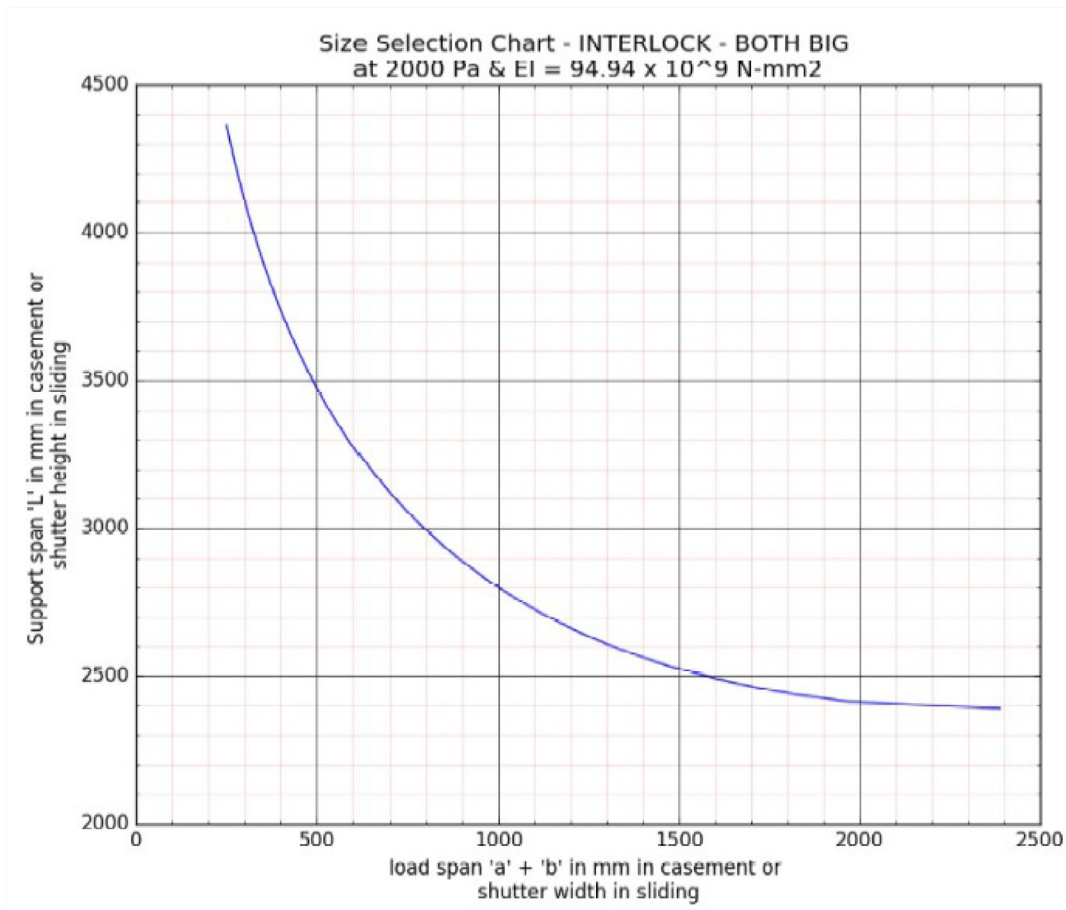
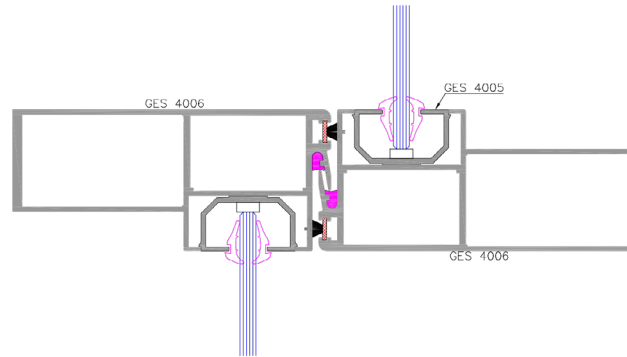

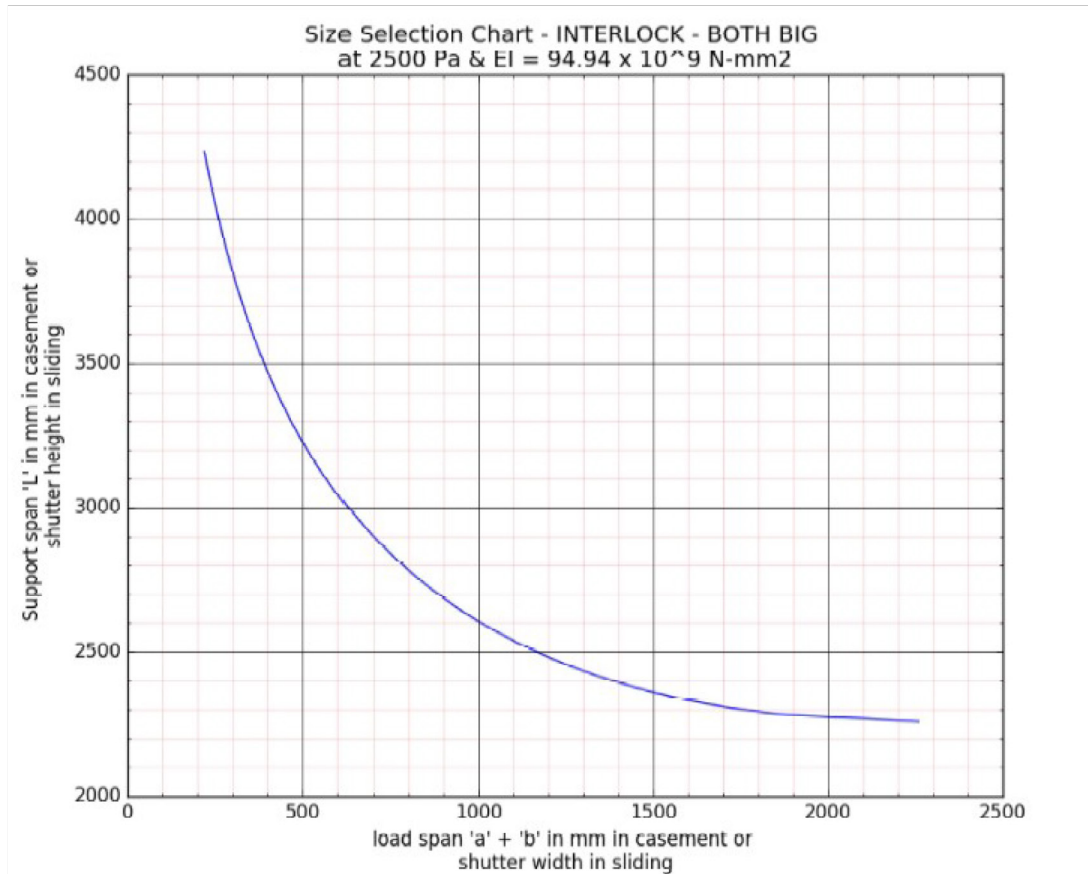
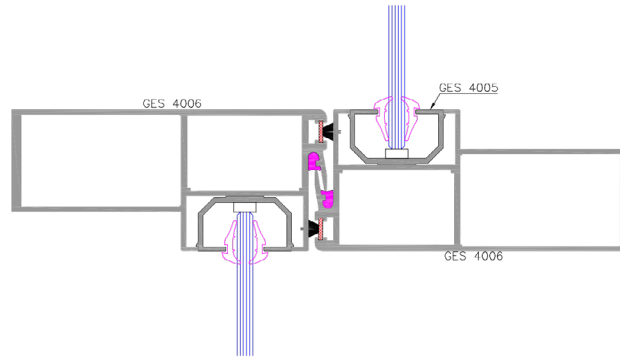

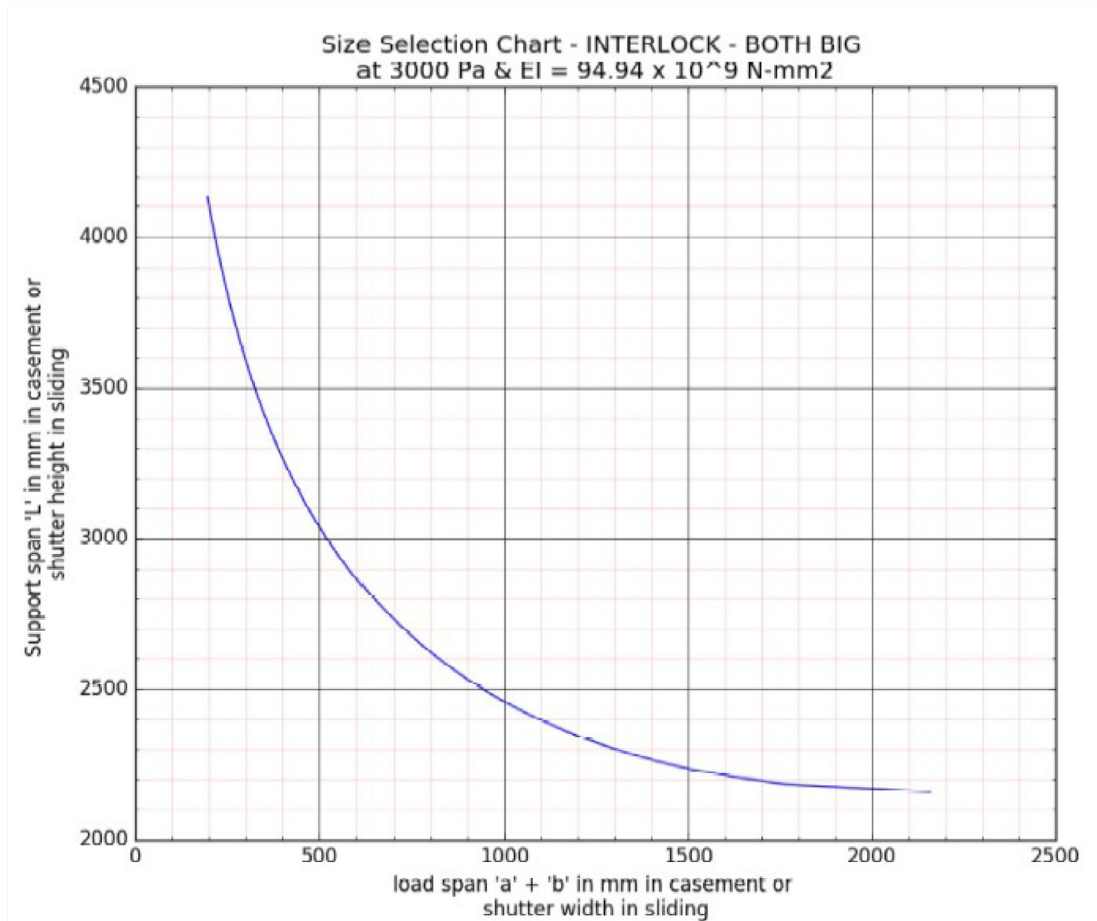
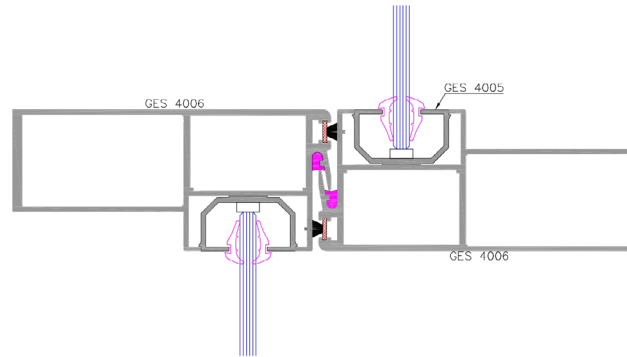

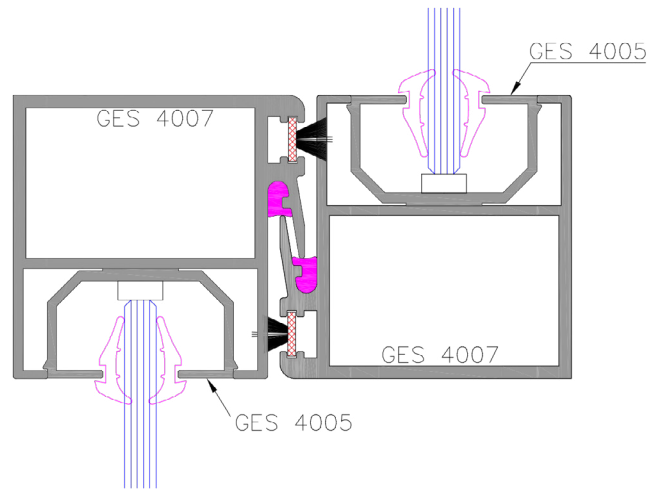

Size Selection Chart - INTERLOCK - BOTHSIDE SMALL  
at 1000 Pa & EI = 14.16 x 10<sup>9</sup> N-mm<sup>2</sup>

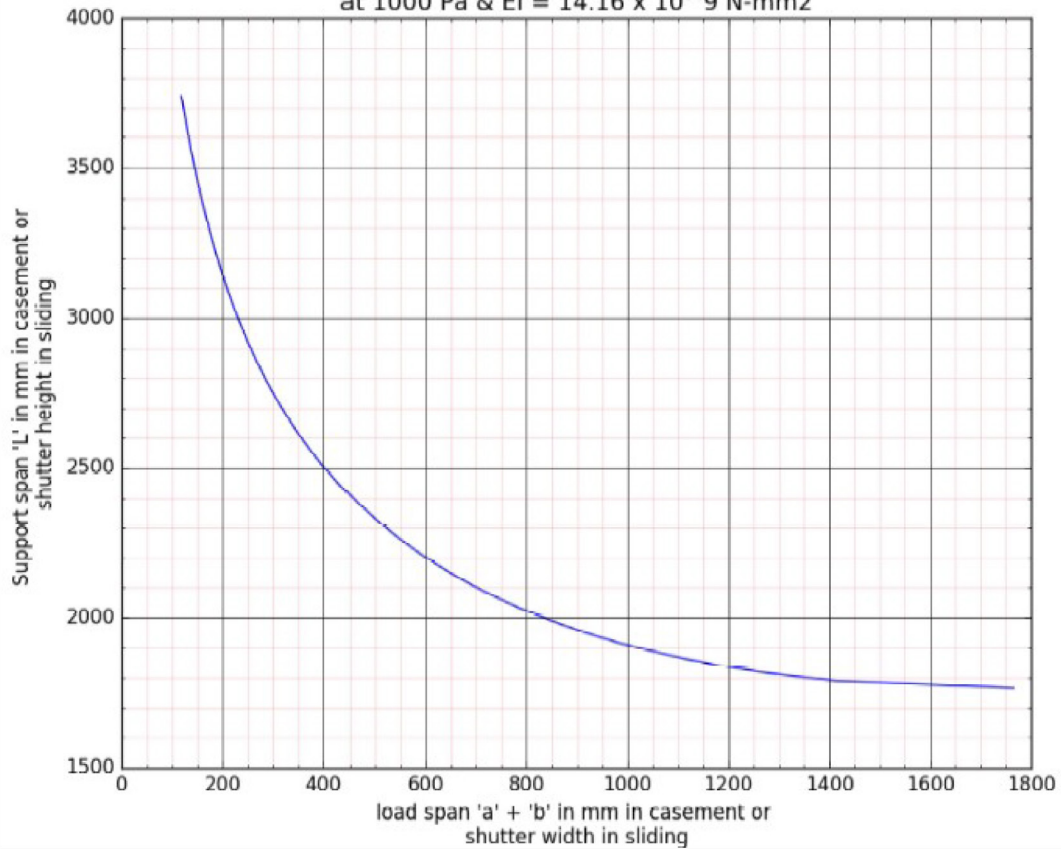

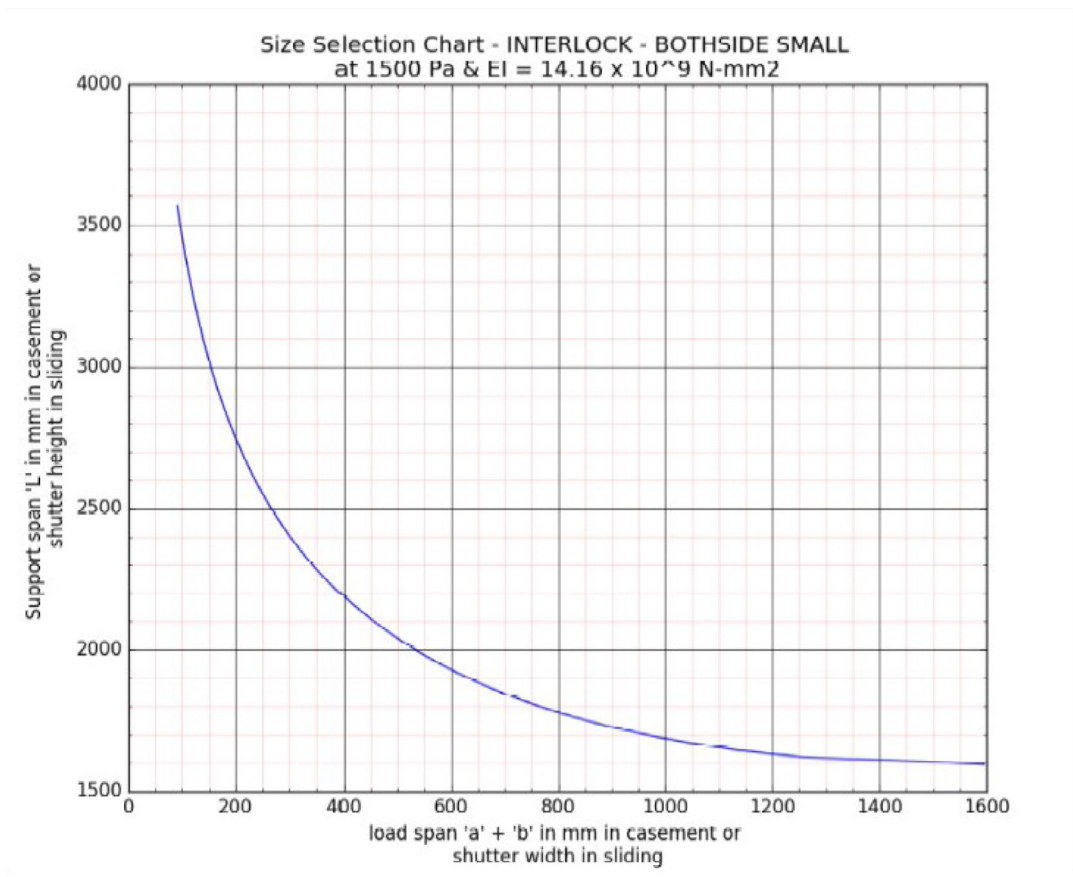
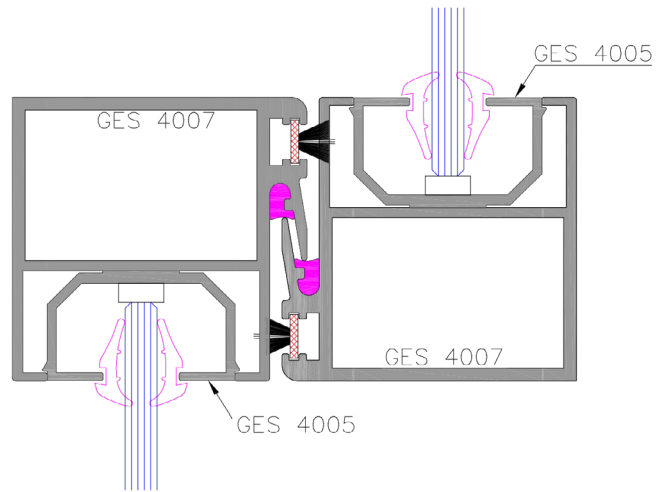

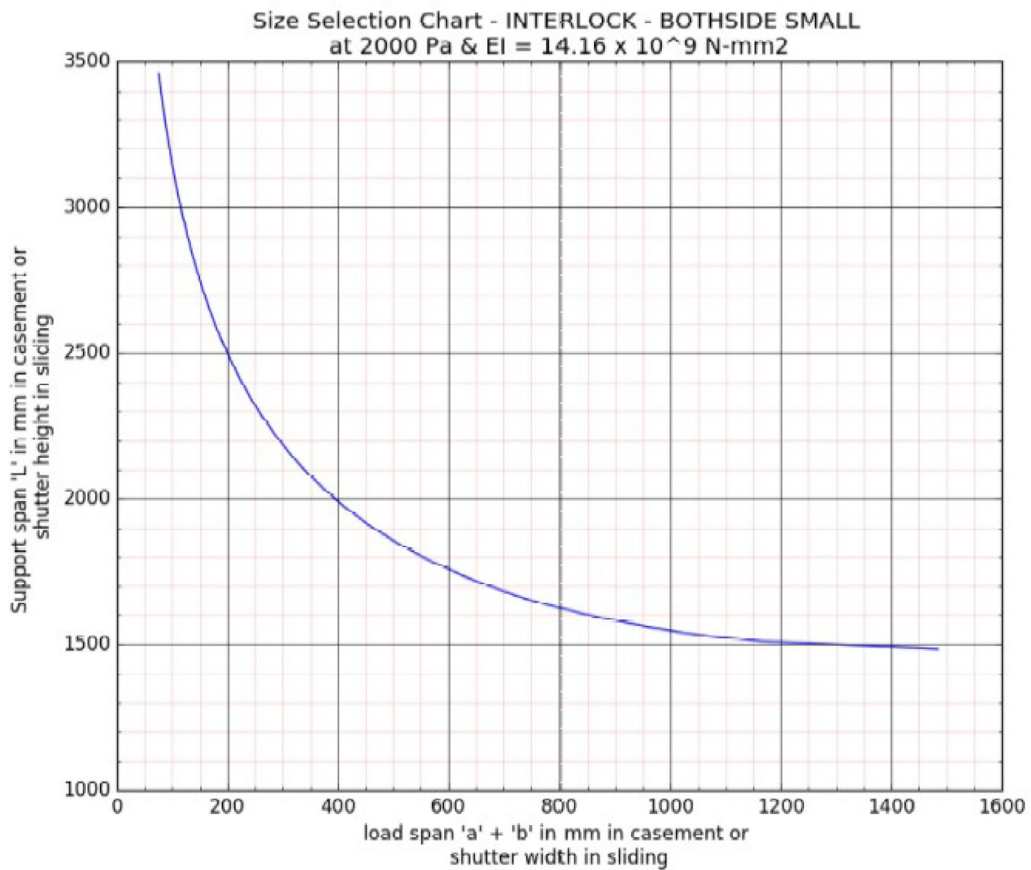
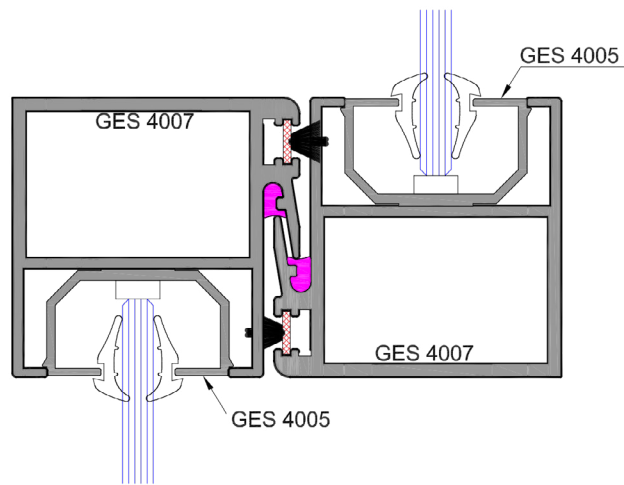

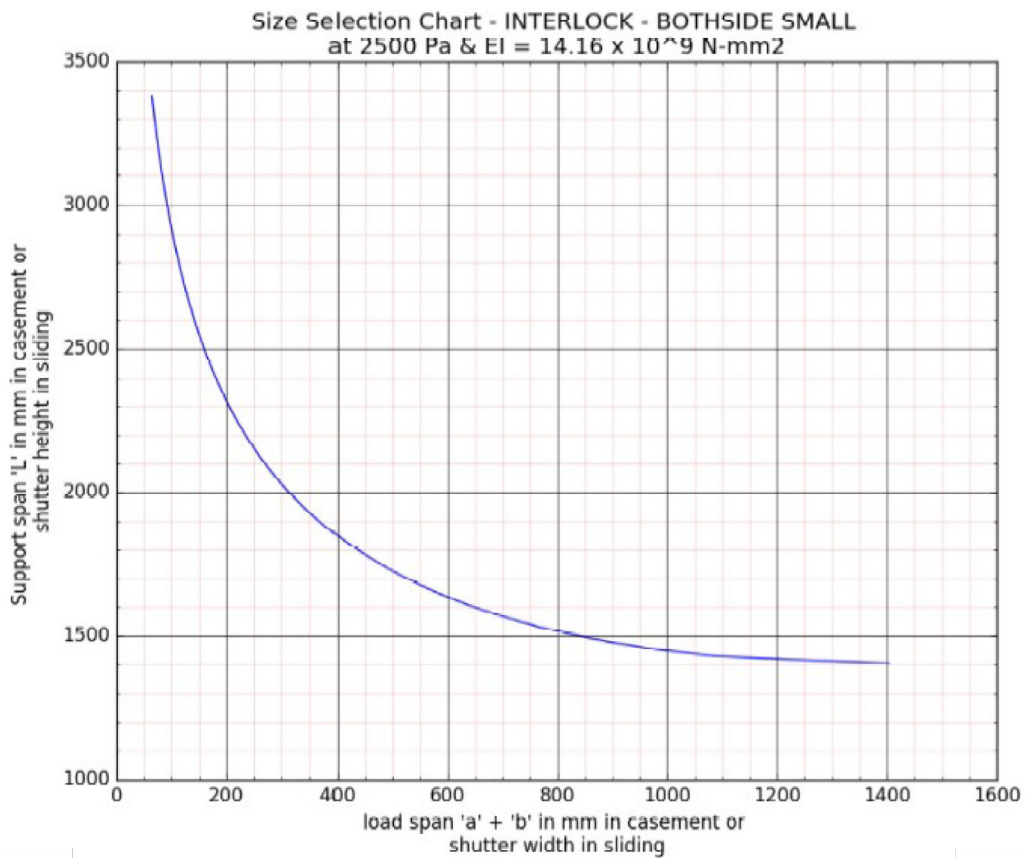
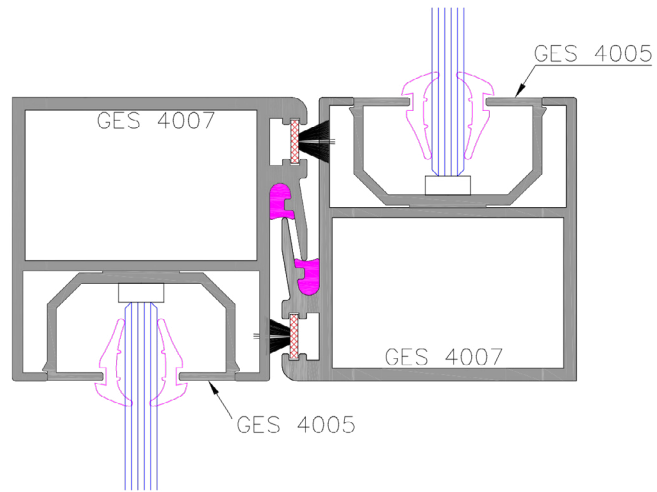

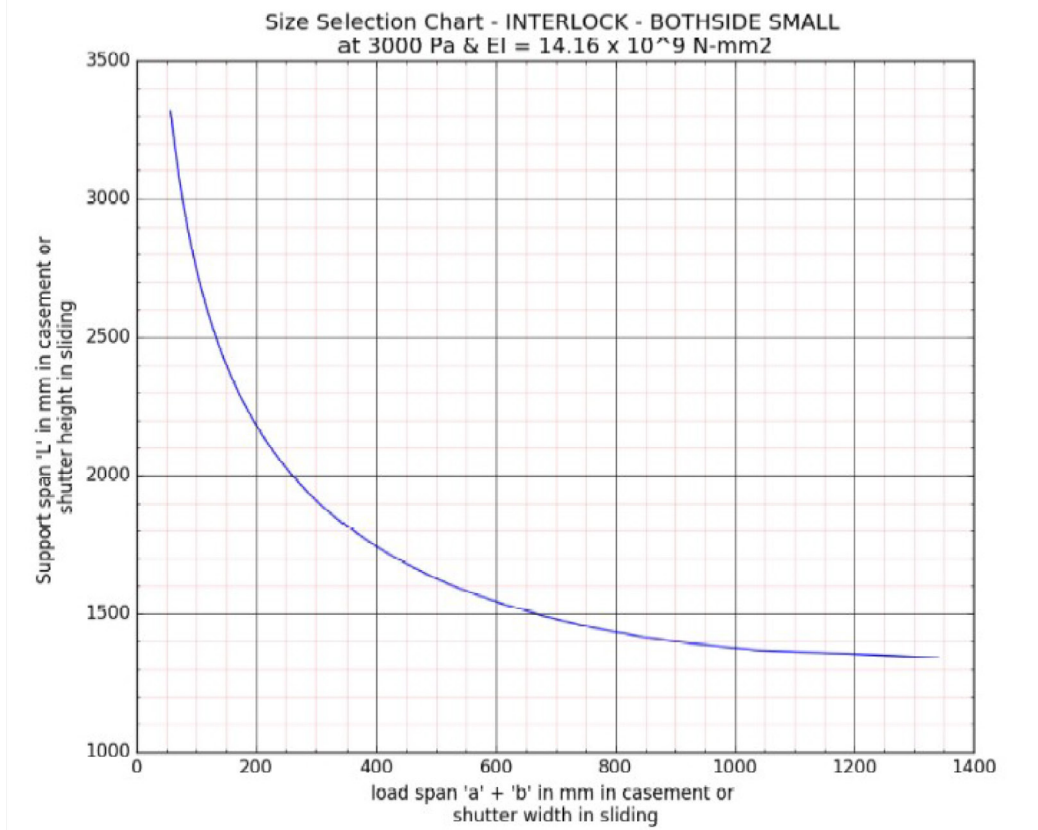
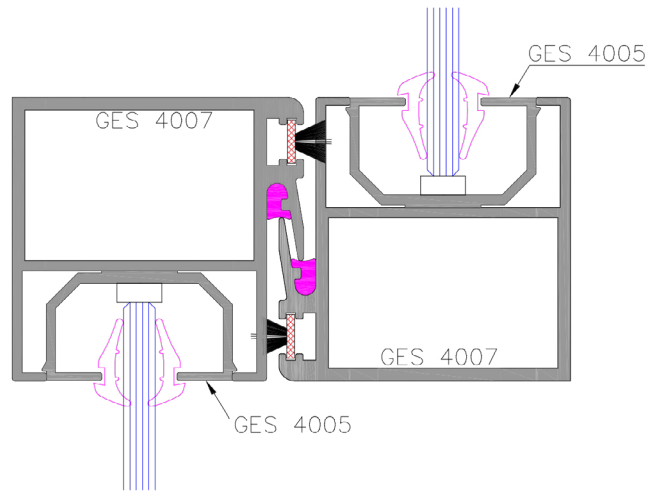

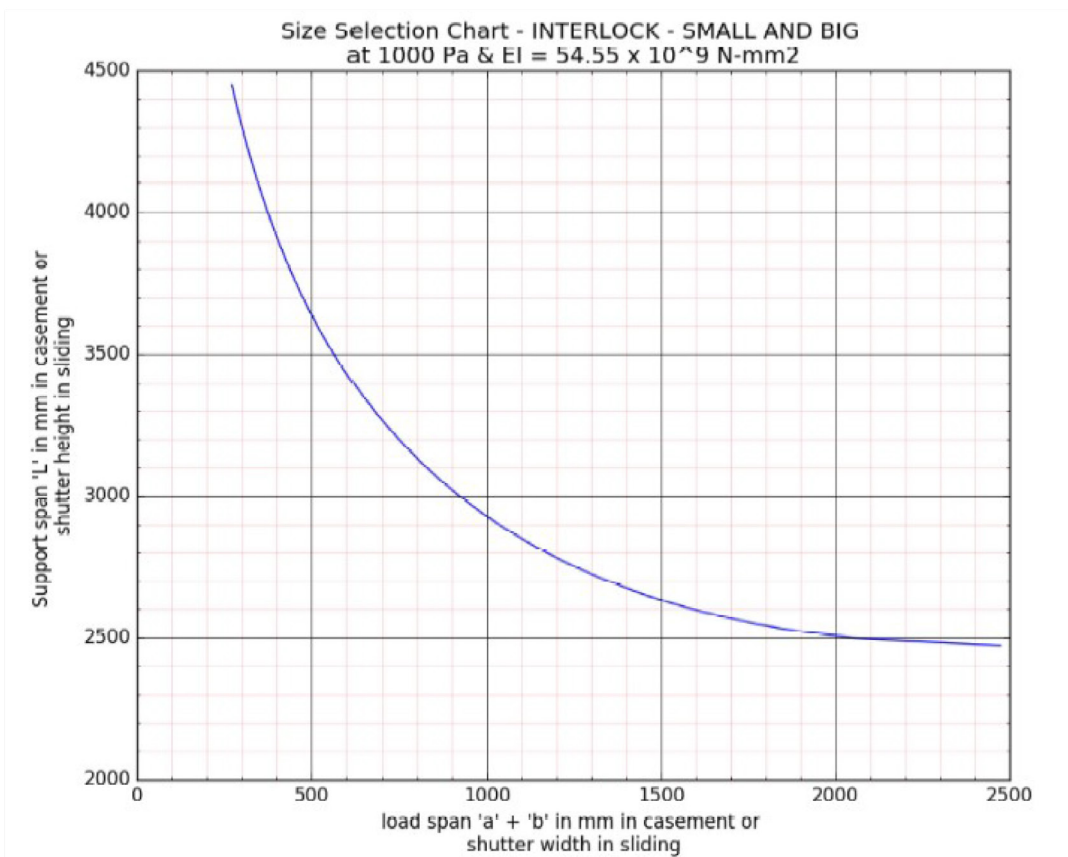
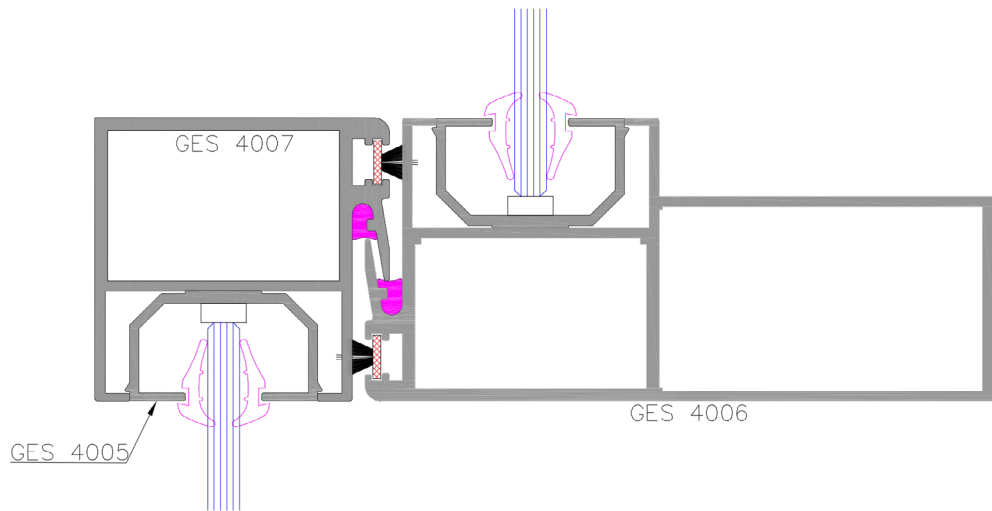

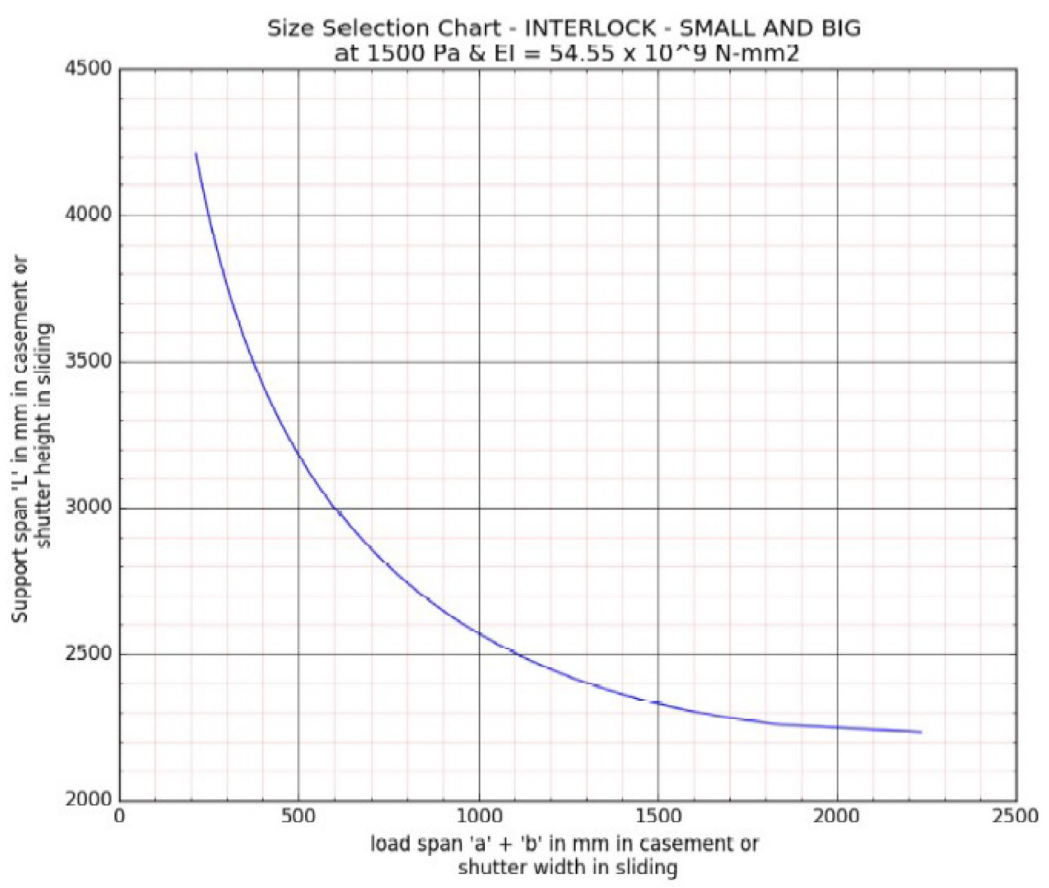
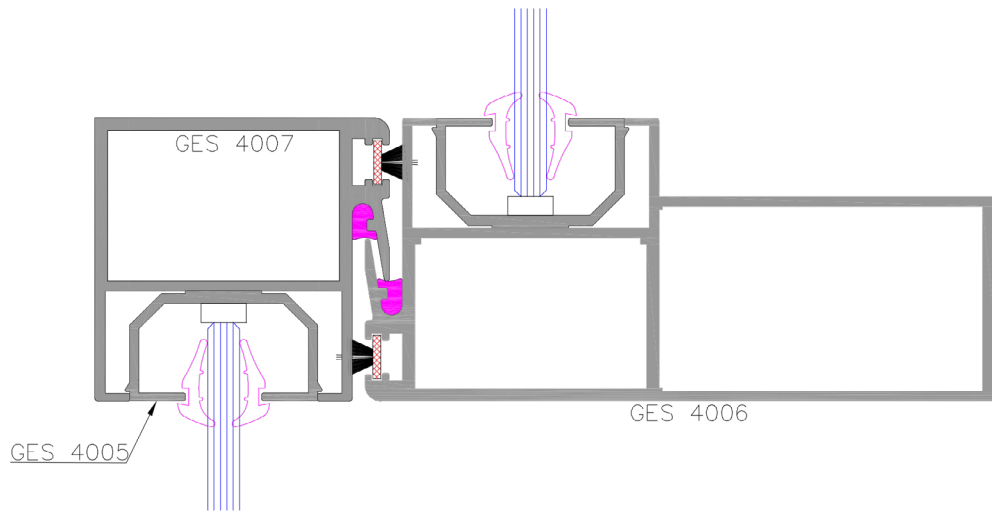

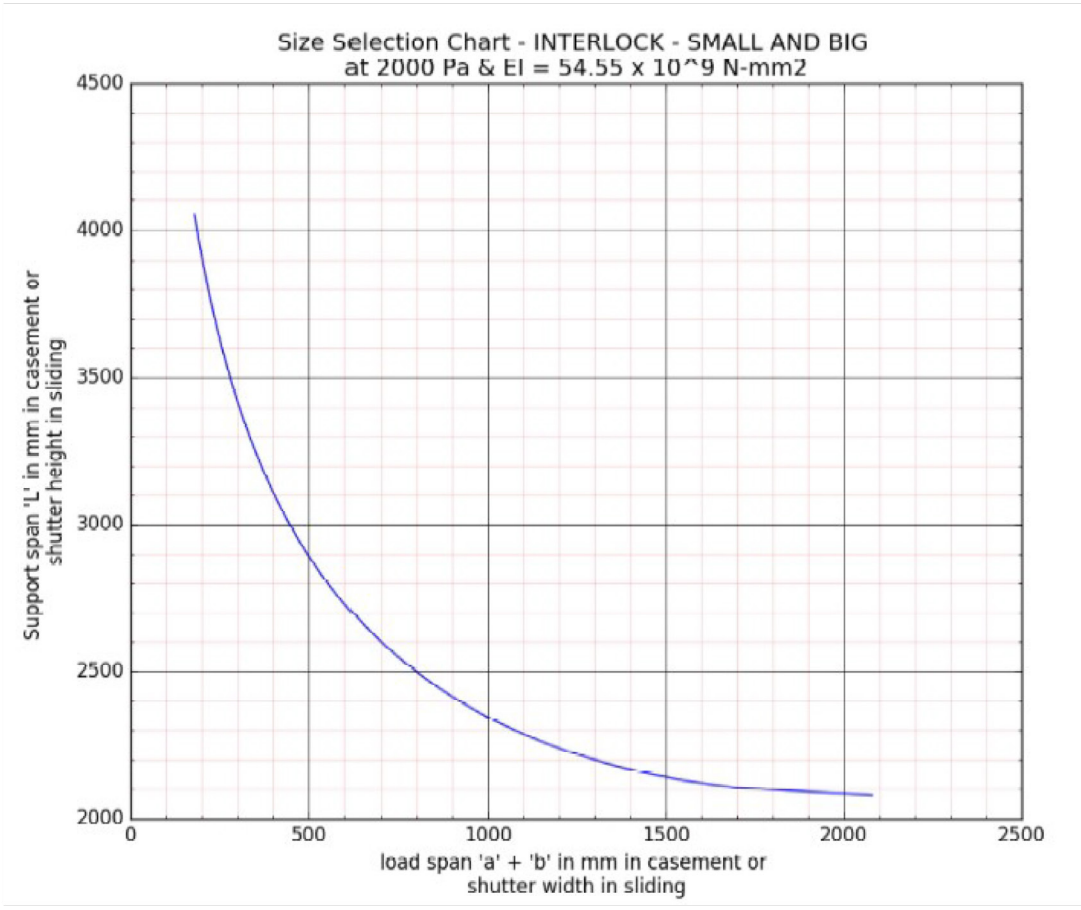
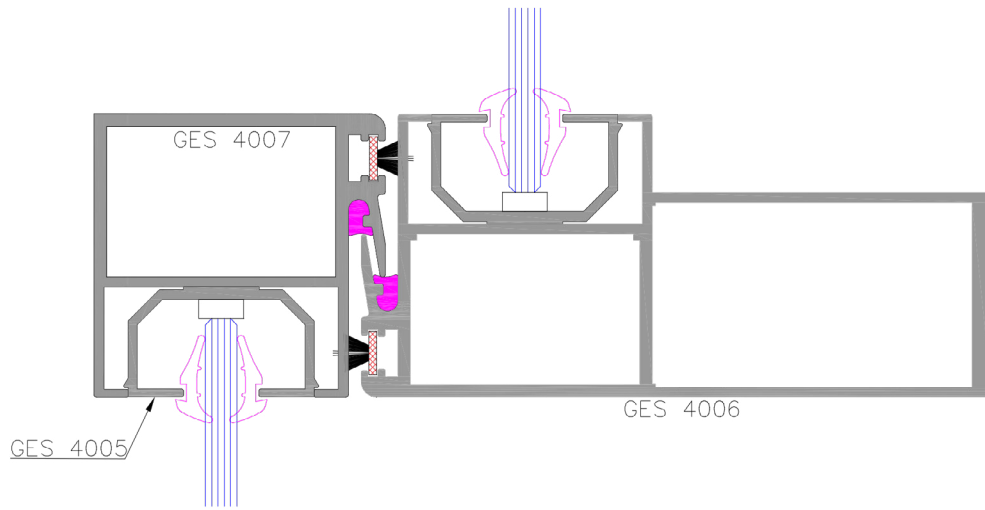

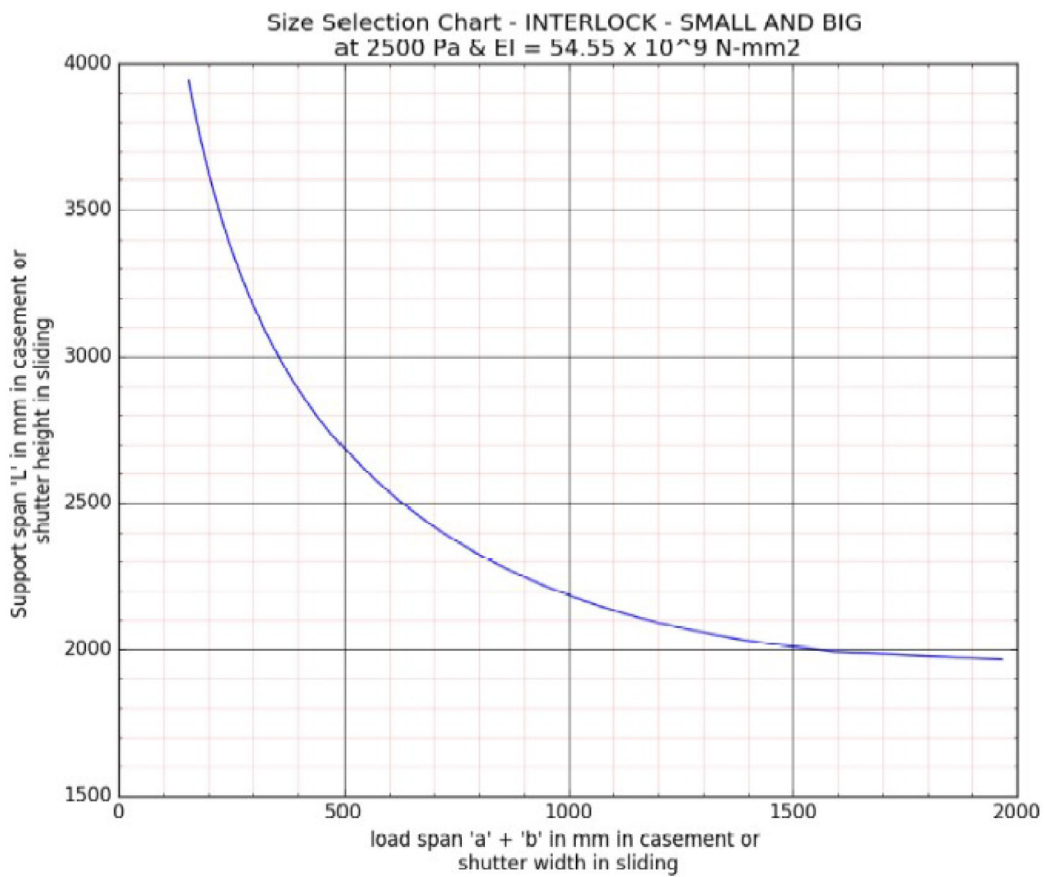
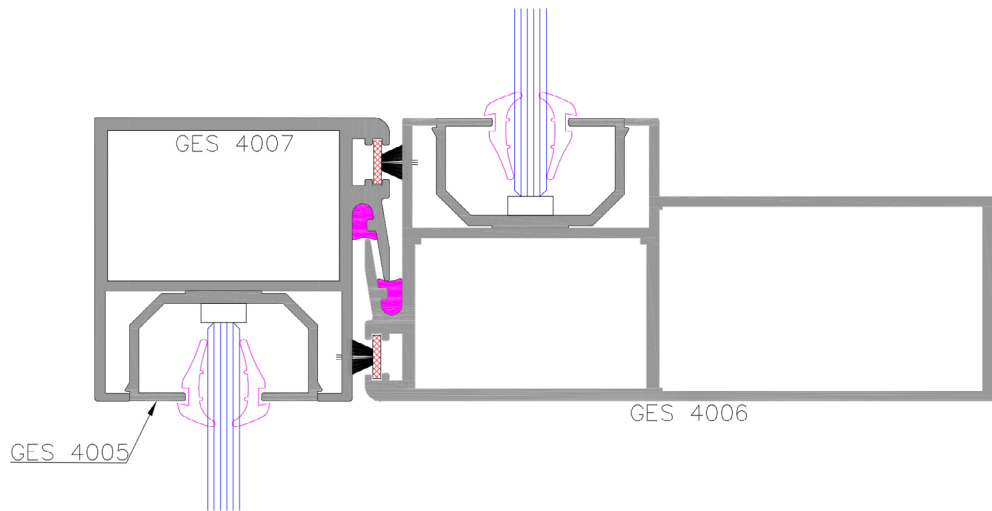

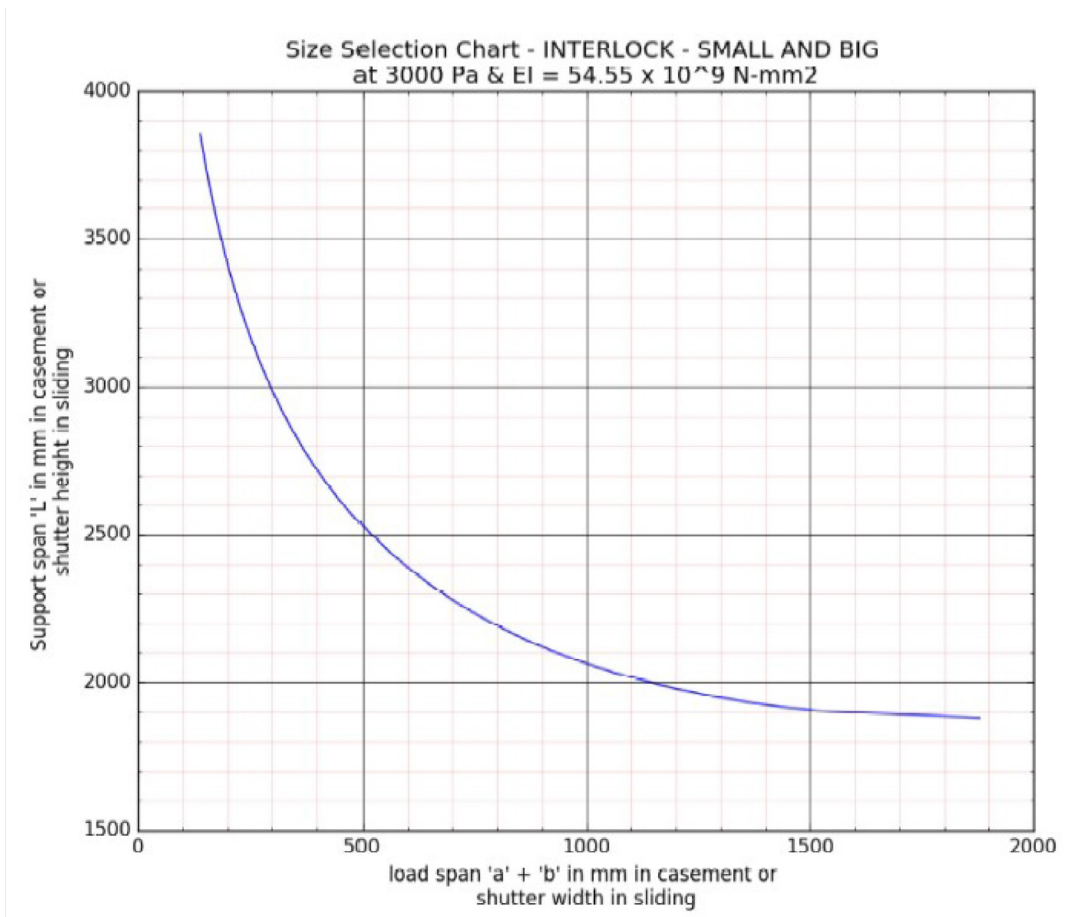
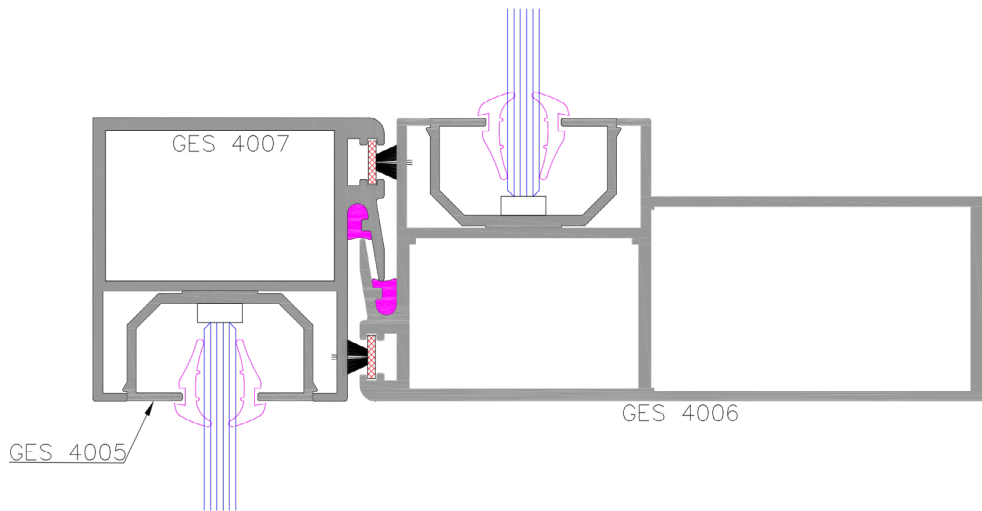

<b>Profile Inertia Details</b>			
<b>SL #</b>	<b>Die #</b>	<b>IX</b>	<b>IY</b>
1	87001	7.756623	54.190352
2	87002	11.120592	1.459787
3	87003	17.11883	410.164832
4	87004	107.223075	10.466281
5	87005	16.555467	41.625276
6	87006	25.845181	41.830533
7	87007	19.546408	11.04391
8	87008	6.6844	10.649104
9	87009	11.467054	72.516872
10	87010	15.185868	9.457447
11	87011	0.431642	1.202835
12	87012	0.169229	0.062271





**NATIONAL ALUMINIUM  
PRODUCTS COMPANY SAOG**

**OMAN**

Corporate Office and Factory  
National Aluminum Products Co.  
PO Box 15, Rusayl, PC 124, Sultanate of Oman  
Phone: +968 24446450, Fax: +968-24446453  
Email: sales@napco.co.om, info@napco.co.om

**UAE**

National Aluminum Products Co. - Branch Office  
PO Box 116912, Dubai,  
Office 34, Shuraa Business Center  
6C Al Abraj St, Business Bay, 29th floor-Prime Tower-Dubai  
Phone: +971 045236200

**INDIA**

NAPCO Extrusions India LLP  
4 , Odyssey IT Park,  
Road No. 9, Wagle Industrial Estate,  
Thane ( West ) - 400604.  
Phone: +91 2220814444

**[www.napcooman.com](http://www.napcooman.com)**